

TRACK 3 TASK 4
WEARABLE AIR POLLUTION SENSORS THAT CROWD SOURCE POLLUTION
HOT SPOT DATA

Team Members



Department of Electrical & Computer Engineering

TABLE OF CONTENTS

1. EXECUTIVE SUMMARY	3
2. INTRODUCTION	4
3. SELECTION OF OPTIMAL DESIGN	5
3.1 Wearable Hardware Design Considerations	5
3.2 Mobile Software Design Considerations	7
4. PROTOTYPE DESIGN	8
4.1 Hardware Design	8
4.2 Android Application Design	11
5. METHODS OF TESTING	13
6. ECONOMIC ANALYSIS	15
7. LEGAL AND PRIVACY CONSIDERATIONS	17
8. HEALTH AND SAFETY PRECAUTIONS	18
9. BUSINESS PLAN	19
10. WASTE GENERATION AND PUBLIC INVOLVEMENT	20
11. CONCLUSION	20
12. REFERENCES	21

1. EXECUTIVE SUMMARY

The [REDACTED] Department of Electrical & Computer Engineering has developed a system in response to the fourth task on the third track of the Waste-Management Educational Research Consortium (WERC) 2018 competition--the creation of a crowd-sourced air pollution monitor. The *Sensore*m project, as it has been named, utilizes both hardware and an Android application to monitor the user's exposure to the five air pollutants regulated by the *Clean Air Act*; ozone, carbon monoxide, sulfur dioxide, nitrogen dioxide, and particulate matter. The *Sensore*m wearable sensor array connects wirelessly using Bluetooth Low Energy (BLE) to an Android phone. Periodically, the measurements are taken from the sensor and uploaded to a Cloud server. In the Cloud, data points are generated by converting the raw metrics aggregated from the sensor into parts-per-million (PPM) and air quality index (AQI), which are then paired with GPS location data from the phone. The data can then be viewed by users of the application as a configurable heatmap of pollutants in the region.

The sensing hardware consists of four industry-standard gas sensors, and an optical particulate sensor, mounted on a printed circuit board (PCB) along with a low-cost, low-energy microcontroller powered by a replaceable lithium-ion battery. The emphasis on low-energy and low form factor allows the hardware component to have an active life that has been measured to exceed one million hours of sensing time^[1] which, depending on sampling intervals, yields a two-to-four-month life cycle per battery. The sensors, in a standard use case, can provide reliable measurements with a resolution of less than 0.02 ppm^[1]. The PCB will be encased in a 3D printed polylactic acid (PLA) case, ensuring durability as well as providing a clip—to provide device wearability.

With the entire system operating on a Cloud-based back-end, the project can operate on any scale, monitoring pollutants in a town, state, or even nationally. Off-device computation and account creation systems allow the application to be light and portable across multiple devices. Additionally, the Cloud can greatly reduce downtime and server maintenance expenses. The project is expected to have relatively economical hardware costs and low operational overhead, costing \$212.72 per sensing unit. The project is forecasted to have little in server costs, costing nothing for the first 50,000 users, increasing only marginally thereafter.

2. INTRODUCTION

The objective of the [REDACTED] Electrical and Computer Engineering Department's WERC competition team is to modernize and streamline environmental monitoring by leveraging the prevalence of internet-connected devices to aggregate air quality data and utilize that data for public awareness and researcher analysis. The *WERC Task 4: Wearable Air Pollution Sensors that Would Crowd Source Pollution Hot Spot Data* outlines an approach for monitoring harmful air pollutants to decrease user exposure and track air quality by region. The five monitored pollutants are ozone (O₃), carbon monoxide (CO), sulfur dioxide (SO₂), nitrogen dioxide (NO₂), and particulate matter comprised primarily of dust, nitrates, and sulfides. These pollutants have been linked to an increased risk for cardiovascular disease, stroke, and lung disease.^[2]

In an effort to more accurately quantify prevalence and exposure to air pollutants, the [REDACTED] Department of Electrical & Computer Engineering developed *SensoreM*. *SensoreM* is a wearable pollutant monitoring clip that a user can attach to their body (clipped into a pocket, a belt, or backpack) that will passively monitor pollutant exposure, informing the user of their intake of certain gases. The device will issue alerts to users who experience dangerously high levels of exposure, detailed in the Health and Safety Precautions section of this report. In addition to informing the individual user, the *SensoreM* project implements a Cloud back-end in order to make data collected available to all users. Whenever a data point is acquired, it is synchronized in the Cloud database, creating a record of a location's air quality index, or AQI, as well as the individual gas concentrations. Further, this allows for the implementation of a heatmap, visualizing the concentrations of each of the gases in their area. Together, these tools offer protection to a user who seeks to minimize their exposure to hazardous gases and particulate matter.

Further, *SensoreM* works to improve the state of pollutant sensing. The Office of Air Quality Planning and Standards (OAQPS), a subdivision of the EPA, is the bureaucratic body in charge of tracking the national atmosphere. However, due to the stationary nature of their sensors, there exist substantial gaps in the air quality control network. *SensoreM* can fill those gaps due to its portability.

Additionally, there currently exist applications for Android and iPhone that allow users to purchase "nodes" or stationary pollutant sensors that can report to a database in a similar fashion. However, these are stationary, and do not provide the user with information regarding their

immediate vicinity. Sensorem distinguishes itself in that capacity, offering users immediate and informed information regarding their pollutant exposure.

3. SELECTION OF OPTIMAL DESIGN

In adhering to the specific requirements elicited from the WERC competition's fourth task, selections for optimal design focused primarily on the construction of the wearable hardware and the development of the application and Cloud back-end. A simplified illustration of the project's operation can be shown in Figure 1.

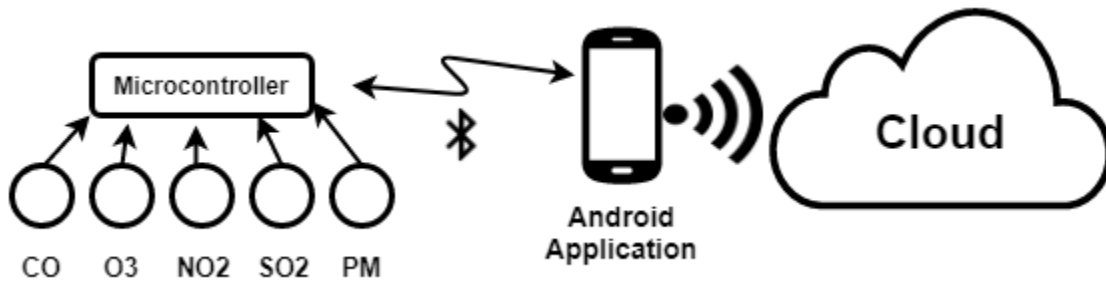

FIGURE 1: Simplified operation diagram

3.1 Wearable Hardware Design Considerations

The wearable hardware component is a sensor array that gathers and transmits data to the phone. The hardware functionality can be considered as a combination of four elements: the microcontroller, sensor array, printed circuit board (PCB), and battery.

The chosen microcontroller is a Feather 32u4 Bluefruit LE using an AtMega 32U4 microprocessor. The Bluefruit offers the exact functionality needed for the project. The controller contains an analog to digital converter (ADC) with seven channels for gas and temperature sensor readings, two external interrupt ports for the particulate matter sensor's pulse width modulated (PWM) measurement and built in Bluetooth low energy (BLE) functionality. The microcontroller gathers the sensor voltages, particulate matter concentration, and ambient temperature, and sends the data to the phone through BLE communication in response to a poll request by the application.

The five sensors measure O₃, SO₂, NO₂, CO, and particulate matter (PM). These sensors were chosen because they are industry-grade and high reliability, with an estimated one error per million hours of sensing time.^[1] The four gas sensors are amperometric electrochemical sensors

connected to an amplification and noise reduction circuit. The circuit converts the current modulation to voltage modulation so that the gas concentration can be measured as a change in voltage. The conversion is carried out by the following equations:

$$M\left(\frac{V}{ppm}\right) = Sensitivity\ Code\left(\frac{nA}{ppm}\right) * TIA\ Gain\left(\frac{kV}{A}\right) * 10^{-9}\left(\frac{A}{nA}\right) * 10^3\left(\frac{V}{kV}\right) \quad (1)$$

$$V_{gas_0} = V_{ref} + V_{offset} \quad (2)$$

$$Cx(ppm) = \frac{1}{M} * (V_{gas} - V_{gas_0}) \quad (3)$$

Where M is the sensor calibration factor, TIA gain is the gain of the transimpedance amplifier (TIA) circuit, V_{gas_0} is the voltage output in a clean air environment, V_{ref} is half of the supplied voltage, and V_{offset} is an offset value found through calibration that counteracts background voltage and noise.

The particulate matter sensor is an optical sensor and uses a different method to calculate particulate material in the air. It contains two output signals, one for small particulates (1-2 μ m) and another for large particulates (3-10 μ m). The low time is compared to a total sampling period of 5 - 30 seconds to calculate the percent occupancy of large and small particles. This percentage is converted to PM concentration in microns per meter squared, μ m/ m^2 , through meters derived from calibration with a known concentration or with the average values provided by the distributor. A summary of its operation can be shown in Figure 2.

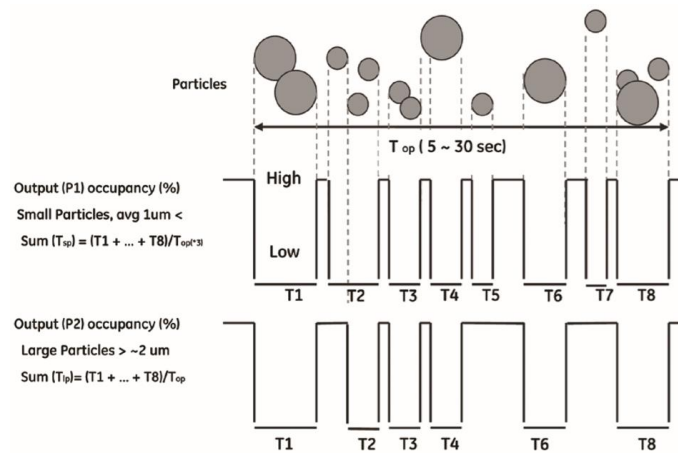

FIGURE 2: Visual of Particulate Matter Sensor Operation ^[3]

The PCB design process was done to remove dependency on the large commercial amplification boards that are currently available as well as combine the sensors and microcontroller into one unit. The amplification functionality was implemented into a custom, compact PCB which houses the gas sensors and microcontroller as one unit.

The choice over type of battery to attach to the circuit was simplified by the restrictions imposed by the microcontroller, which was designed to operate on a 3.7V DC input. This limited design options to a series connection of button cells or a DTP 603443 rechargeable lithium ion battery. The DTP 603443 made the most sense given its compatibility with the microcontroller through a specialized harness.

To protect the sensor hardware in any use case, the hardware would need to be attached to the user in a safe and effective way. The Sensorem team chose to encase the array using basic polylactic acid (PLA) as opposed to more expensive alternatives, such as acrylonitrile butadiene styrene (ABS). PLA was also chosen for its renewable nature, as it is derived from corn and cane sugar^[4], and time and cost-effective development processes. For testing and development, printing through the Department's 3D printing studio reduces overhead expenses and the offers density variation of the material serves the project's needs. In deployment, PLA housings could be manufactured affordably from a number of reliable distributors.

3.2 Mobile Software Design Considerations

In building the application, multiple design decisions had to be made. Foremost of which was what operating system to use for deploying the prototype. In a decision between building on the Apple iOS platform and Google's Android platform, Android was seen as the preferable route. Android was chosen due to teammate experience in the Android development field, as well as the operating system's superior building environment and documentation related to Bluetooth and BLE protocols.

Another important decision was between methods of storing the user-collected data. The factors identified as most important were; project scalability, server uptime, economic feasibility, server security, and ease-of-use. The decision was made between a locally hosted server and a number of different Cloud service providers. Research demonstrated that a locally hosted storage server would be not be a viable option due to the forecasted lapses in uptime, scalability, security and initial capital investment^[5]. This left the design consideration to a choice between three

different Cloud service providers: Google Cloud Platform, Microsoft Azure, and Amazon Web Services. All three offered a 99.9% uptime^[5] as well as secure data storage. Additionally, given the functionality of a Cloud data center--independent of provider--the project is scalable. Since the providers were similar in most quantifiable aspects, the decision factors reduced to ease-of-use and economic feasibility. Between the three, Amazon Web Services (AWS) offered the most with the least capital investment. AWS has a free plan that offers 25 Gb of cloud storage, with 200M requests per month. The AWS Cloud back-end, referred to as the Mobile Hub, can accompany up to 50,000 users before payment is needed. For the sake of prototyping, these are generous margins. Should deployment exceed this, all resources port over to a paid plan seamlessly.

TABLE 1: Cloud Platform Free Usage Parameters^[5]

Feature	Free Usage Constrictions
Secure Authentication	50,000 monthly active users
Database Storage	25 GB indexed data storage. 200M requests/month
Cloud API	1,000,000 API calls 400,000 GB-seconds of compute time (per month)
Messaging & Analytics	5,000 targeted users 1M push notifications 100M analytics events (per month)

4. PROTOTYPE DESIGN

4.1 Hardware Design

The inherent low energy design of the sensors necessitated the creation of an amplification circuit. Such amplification and noise reduction circuits were applied to each of the four gas sensors. Each of the modules is individually designed for its respective sensor as the TIA gain and bias

vary depending on the gas type of sensor. A thermistor circuit was added to record temperature fluctuations as they can affect the gas sensors operation. The PCB was made to be as wide as the particulate matter sensor such that it may sit flush with it on the same vertical dimension while the battery and microcontroller are oriented underneath, to conserve space. The fully assembled board allows for the sensors to operate and be measured by the microcontroller. Compiled C code on the microcontroller will respond to query requests from the application, prompting it to transmit raw sensor data to the phone over Bluetooth Low Energy communication.

The PCB in Figure 3, below, is the schematic of the board. Each of the gas sensors is separated into four quadrants while the temperature sensor is located in the center. The sensors are all located in close proximity in order for them to access the same air sample. To save space, the microcontroller is oriented on the opposite side to conserve space and easily communicate with the sensors via ADCs. The battery is oriented directly next to it and fits within the confines of the PCB's outer limits. The top of the board houses the 5-pin plug for the dust sensor as well as the 3.3V to 5V converter circuit. The board was designed to have the same width as the particulate matter sensor, 59mm, seen in Figure 4. This was done to ensure a case that could wrap around the entire sensor array and the PM sensor for added support, stability, and case design simplification.

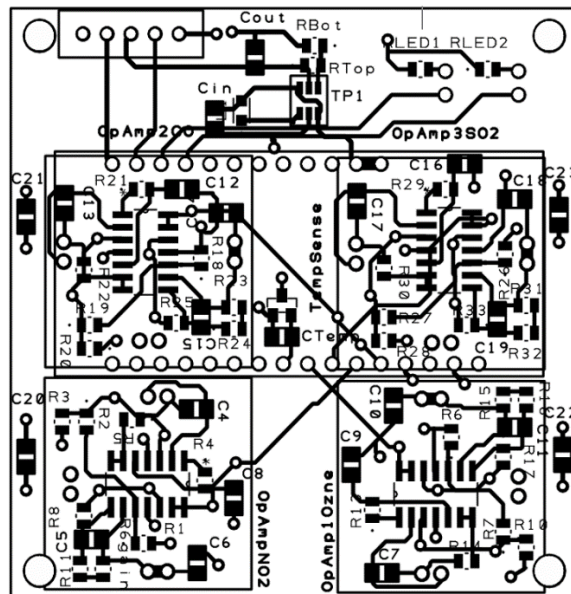

FIGURE 3: Custom PCB sensor array

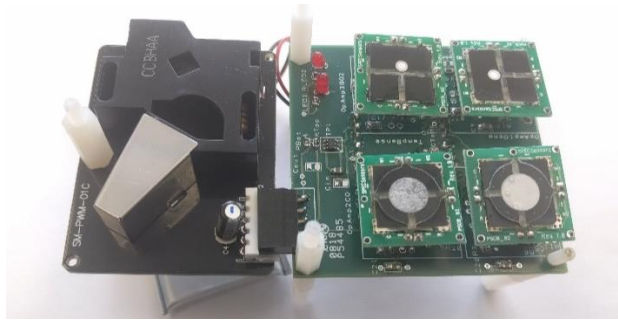

FIGURE 4: Finished PCB design and particulate matter sensor

The microcontroller had to be programmed to take readings from each of the sensors and communicate with the device simultaneously. To make sure the program would run efficiently it was important to implement a process hierarchy show in Figure 5.

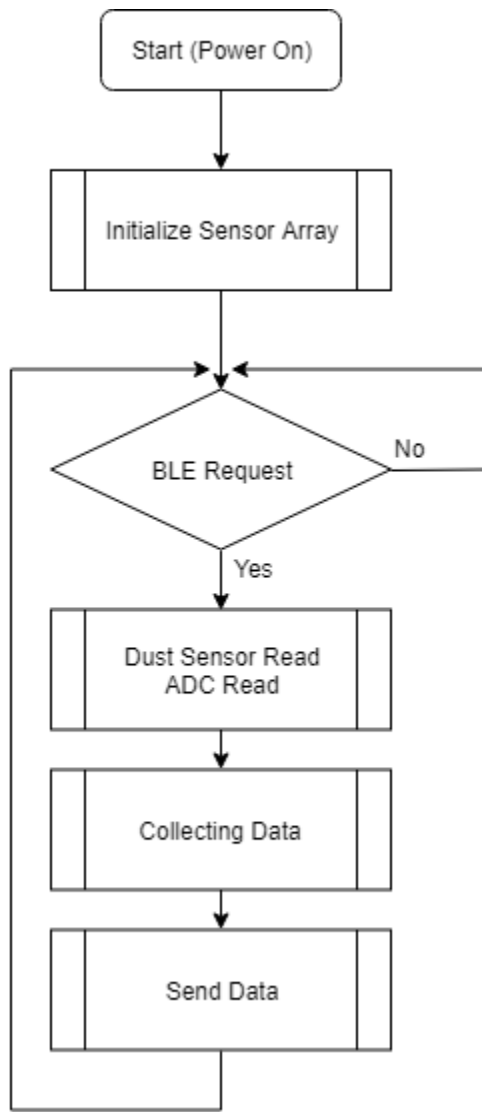

FIGURE 5: Flow Chart of Microcontroller Program

The microcontroller software is built around a poll request from the Android application. Upon reception, the microcontroller follows the above schema. The PM sensor requires a sampling period of 5-30 seconds and therefore cannot be polled instantaneously. The program waits for a sampling cycle to be completed by the PM sensor. Once the data is updated, the ADCs for each of the gas sensor and the temperature sensor is read. This process only takes a few milliseconds. The data from all the sensors is arranged into an ASCII string and then sent through BLE to the app.

The attributes of the case were derived from its expected functionality. the battery will require charging periodically and will therefore need to be accessible. The gas sensors require exposure to the atmosphere, but protection against dust and other particulates. To address this design issue, a polyurethane foam covers the sensor array. The particulate matter sensor, which detects particulate between 3-10 μm , may have its readings distorted by even coarse fabric ^[3]. Finally, the microcontroller power switch is designed to be exterior, allowing for power to be toggled without opening the housing.

With all of that considered, the case had to be able to withstand rugged, everyday use, with an emphasis in securing the fragile sensors. This was achieved by printing a custom, tight fitting polylactic acid (PLA) cover. In an effort to make the sensor wearable, a clip was added to the back-facing side which allows the device to be secured by the chassis to the user.

4.2 Android Application Design

The application consists of two primary pages, or *activities*, the Main Activity and the Maps Activity. The Main Activity displays information immediately relevant to the user. This includes the connection status of the Sensorem wearable hardware, as well a counter of how many data points the device has contributed cumulatively. Below the hardware status tile is a report of parts-per-million (ppm) concentrations of the pollutants in the air, according to their sensor's latest reading. By clicking on each of these concentrations, more information is made available regarding how those concentrations will affect the user over time. Concentrations are converted to the Office of Air Quality Planning and Standard's air quality index (AQI), a national standard in atmosphere quality. Additionally, readings at a high enough level trigger a notification to the user regarding the pollutant. The concentrations are color-coordinated depending on severity, ranging from safe (green) to hazardous (black), again in compliance with AQI standards. More can be read about the

OAQPS and AQI in the Health and Safety Precautions section. On the bottom of the screen, the user will have options to direct them to the settings menu or the Maps Activity.

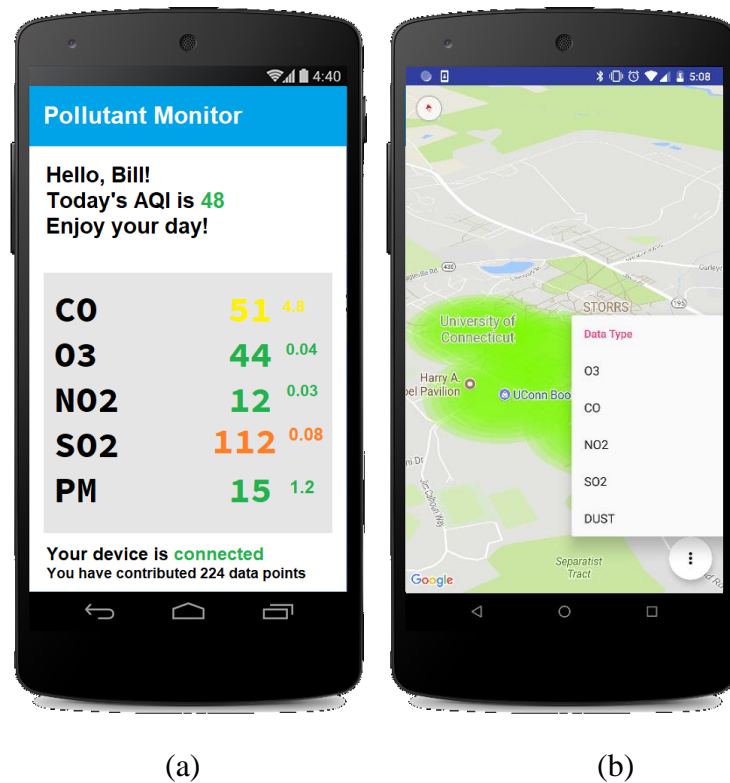

FIGURE 6: Main Activity (a) and Maps Activity (b)

From the Main Activity, Figure 6a, the user can swipe to the right to Maps Activity, Figure 6b, or click the button (not pictured). Once on the maps page, the user can use a floating action button in the bottom right to interact with the heat map. The heat map will have two operating modes; user specific data and cumulative thirty-day data. The former will allow the user to visualize all of the readings gathered by their device over the last month, while the latter will query the entire database and display a heatmap incorporating every data point accumulated by every device. Further, the floating action button will allow the user to choose which heatmap they are observing on the map.

These two activities will cover the primary function of the application. However, there are a host of other activities. The user will have access to a settings menu, in which they can connect the Sensorem hardware, opt-out of submitting their data to the database, and read the privacy statement and terms and conditions. The ability to opt-out is related to privacy concerns addressed in the Legal and Privacy Considerations section of this report.

5. METHODS OF TESTING

The hardware was tested in a two step process. First, the functionality of the custom PCB was verified by comparison to industry equivalent circuits, including those provided by the sensor manufacturer. To compare the circuits response, the voltages between the proprietary circuit and the PCB were measured. The responses were consistent between the platforms and indicated matching circuitry. Once the consistency check was completed, final bias voltage alterations were made to insure correct sensor response. Once the PCB was determined to output acceptable voltages, the entire circuit was calibrated.

The latter step was calibrating the gas sensors. First, the sensor board was placed inside of a chamber next to a high-grade sensor of the same gas type and the chamber was flushed with argon to obtain V_{gas0} , the voltage of a clean air environment. The chamber was then filled with various concentrations of the gas and voltage measurements were taken. Below are the testing results for ozone, though all gases would have followed an identical process.

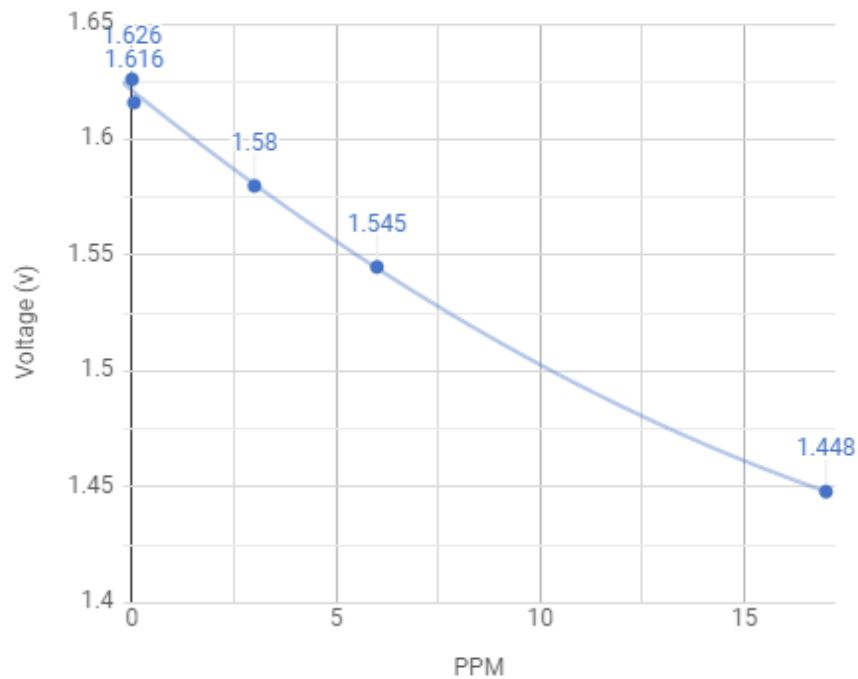

FIGURE 7: Ozone Sensor Calibration Data

The result was mostly linear, as shown in Figure 7, but fit closer to a polynomial trend with a very small deviation ($r^2 = 0.998$). This equation was used to calculate the offset voltage value

throughout the sensor's entire operating range of 0 - 20 ppm. Unfortunately, acquiring sufficient quantities of the rarer gases, such as nitrogen dioxide and sulfur dioxide proved prohibitively expensive (see Economic Analysis). Therefore, an alternative approach was necessary. The calibration of these sensors was derived through data from real world sources and approximations and were used to achieve acceptable accuracy.

The particulate matter sensor was treated differently. Since there were no available particulate matter samples to be used, a vacuum chamber was used for a zeroed reading and linear behavior was assumed. The data sheet provided by the manufacturer indicated a conversion ratio between LPO (Low Pulse Occupancy Time). A reading was taken in a clean chamber for a zeroed response for calibration.

In deployment of the Sensorem technology, the sensor array and system will need to be validated by comparison to calibrated gas sensors. The sensors were individually balanced using the same method, but they may alter their performance in an actual use case. Particularly the operation of the particulate matter sensor, whose optical sensor is error prone if the device is vibrating, since the infrared may register the same dust particle multiple times, skewing data.

An additional consideration is that the sensors have a temperature limitation. To avoid the issue of an overheated gas sensor construing data, the temperature will be checked from the temperature sensor first, in order to confirm that the device is within the operational temperature range.

The software testing was an iterative process. Since the Android application acts as an intermediary between the Sensorem hardware and the Cloud database, the back-end application development was focused on the interconnection between the three devices.

First, the connection to the Cloud was ensured. This was done by logging a confirmation in the debugging terminal when the app authenticated its connection. From there, the next step was to implement an account system, in order to differentiate between contributors to the Cloud database. This functionality was ensured by logging into the same account across multiple devices.

Once the connection and account creation functions were certified, a function was created to assemble fake data from the Sensorem hardware. This fake, or *dummy*, data was used to verify that the Cloud database behaved correctly and had all the correct fields. The database query function was then created to verify that the heatmap would be able to pull the data it needed from the database. The next step was to receive data from the hardware itself.

The Bluetooth low energy was tested originally using an application on an additional phone that emulates a BLE Internet of Things (IoT) device. The connection between the two phones would mimic the connection between the phone and the Sensorem hardware, which at that point was not ready to transmit data. Once the device with the Sensorem application was able to transmit and receive data from the emulated BLE device, as well as scan for BLE devices in the area, the functionality was tested on the Sensorem hardware.

After all connections were demonstrated to be functional, the system was tested as a whole. Using a short sampling interval, the data was polled by the phone and received from the hardware, which was transmitted to the database.

With functional data, the application's heatmap was confirmed by comparing the data displayed on the map with the data logged into the database by the hardware. When the values were assessed to be the same and the GPS data was determined to be accurate, it was confirmed that the heatmap was functioning as expected.

6. ECONOMIC ANALYSIS

In evaluating the cost of the system, the cost is--expectedly--the hardware. The high individual price per sensor and the broad range of sensors utilized constitutes roughly half the total expense. Paired with the microcontroller and the custom PCB, the module is estimated at \$212.72 per unit. The table below contains all of the associated costs one sensing module would cost to produce.

TABLE 3: Expected Expenses Per Unit

Item	Quantity	Cost
Adafruit Feather 32u4 Bluefruit LE	1	29.95
PCB	1	66.00
O3 Sensor	1	20.00
NO2 Sensor	1	20.00
CO Sensor	1	20.00
SO2 Sensor	1	20.00
Dust Sensor	1	14.82
Li-Ion Battery	1	9.95
Case	1	4.00
Miscellaneous		8.00
Total		212.72

The cost can be lowered substantially if components were to be purchased in bulk, especially expenses related to the printed circuit board.

Another substantial expense is the cost of calibration for the gas sensors. Since calibration is conducted by exposing the sensors to varying concentrations of gases, acquisition of these gases need to be considered. That said, the costs can be made more economical by testing sensors in batches, reducing the per-unit overhead. The costs are estimated below using a forecasted quantity of 400g at over 95% assay.

TABLE 4: Expected Expenses Per Calibration Session ^[6]

Gas	Cost per 400-450g
Carbon Monoxide (CO)	\$277.50
Ozone (O ₃)	\$12.25
Nitrogen Dioxide (NO ₂)	\$557.00
Sulfur Dioxide (SO ₂)	\$409.50

The labor costs associated with this would be minimal, as the PCB fabrication process is extensively automated. The soldering of components is a process that has been automated but would also add to the cost. Staffers would be required to observe the data collection and account for major discrepancies or distorted data, as each of the boards could be damaged and still transmit data.

7. LEGAL AND PRIVACY CONSIDERATIONS

Accessibility of the data collected is an important project component to the [REDACTED] WERC competition team. Of course, when dealing with data that involves fine GPS locations, a case can be made against free and open access. For this reason, the application and functionality are built with *Privacy by Design (PbD)*. PbD is a set of guiding principles for ethical online advertising and use of consumer data. Despite the application not utilizing advertising or accumulating consumer data (with the exception of GPS data and email address), the design team at UConn deemed it critical to take every privacy precaution and protect the application from the most malicious abuse cases.

The foremost step taken towards privacy protection is the obfuscation of user identification keys (user IDs) from all users, including researchers who may access the database. Even though these are randomly generated universally unique identifiers (UUIDs), a malicious actor could use them to track a particular user.

Further, a delay is taken into account when collecting data to display on the heat map. In order for the project to operate on a large scale and still maintain individual privacy, a user's data cannot be appearing in real-time, as it would give anyone with the application the whereabouts of the other application users. A delay between 36 and 48 hours allows for the data to be displayed without compromising the privacy of the end users.

For users who do not wish to have their data submitted at all, there is the ability to opt-out and not have their data displayed in the heat map. This data will still be submitted to the database, maintaining the applications portability between devices, but it will be flagged as "excluded" and will not be pulled in queries from the device to populate the heat map. Opting-out will be an option available in the Settings menu of the application.

8. HEALTH AND SAFETY PRECAUTIONS

The project is a response to the link between air pollutants and a host of diseases, including cardiovascular and lung disease. Professionals at the American Heart Association find that even short-term exposure to acute air pollution can be hazardous for the elderly and those predisposed to heart disease ^[2]. Long term exposure can prove deleterious to even healthy young people. The *Sensore*m project aims to address those concerns by offering a wearable air pollution monitor.

Air quality is monitored under the *Clean Air Act*, Title 40 of the Code of Federal Regulations, Subchapter C. Parts 50-97. The *Clean Air Act* distinguishes the Environmental Protection Agency (EPA) as the authority over air pollutants ^[8].

In calculating advisories, *Sensore*m follows the guidelines proposed by the Office of Air Quality Planning and Standards (OAQPS), a subdivision of the EPA. OAQPS creates a single index for air quality that describes pollutant concentrations into five categories; good, moderate, unhealthy for sensitive groups, unhealthy, very unhealthy, and hazardous. The air quality index (AQI) and its corresponding regions for the gases observed are transcribed in the below table.

TABLE 5: AQI of Four Pollutant Gases in PPM^[9]

AQI	0 - 50 (Good)	51-100 (Moderate)	101-150 (Unhealthy for Sensitive Groups)	151-200 (Unhealthy)	201-300 (Very Unhealthy)	301-500 (Hazardous)
Carbon Monoxide	0-4.4	4.5-9.4	9.5-12.4	12.5-15.4	15.5-30.4	30.5-
Ozone	0-.054	.055-.070	.071-.085	.086-.105	.106-.404	.404-
Nitrous Dioxide	0-.053	.054-.100	.101-.360	.361-.649	.650-1.249	1.250-
Sulfur Dioxide	0-.035	.036-.075	.076-.185	.186-.304	.305-.604	.605-

Further, every effort is made to ensure that the sensors are precise and calibrated, however, in the Terms and Conditions that will have to be agreed to prior to using the system, the readings should not be taken as official readings or form the basis of legal decisions. By making this distinction, it is important to note that the *Sensore*m team is not liable for any confusion related to distorted or imprecise data gathered from the sensors. Federally, the Environmental Protection

Agency has jurisdiction over the monitoring of air quality throughout the nation. On the state level, alerts related to high concentrations of potentially harmful pollutants fall under the authority of the state regulatory agency, in this instance the New Mexico Environment Department.

9. BUSINESS PLAN

The Sensorem hardware and application system lends itself to multiple routes for monetization. The use case addressed throughout the paper assumes a user-facing open-source business model, marketing towards individuals with an interest in monitoring pollutant intake. This method can be profitable, but the aforementioned cost may be prohibitive. An alternative approach involved marketing towards larger entities through private and public contracts.

Expanding on a user-facing approach, the product can be solicited to users and operated as an open-source database, useful for public reference. This method would permit the most transparency, as the code for the application could also be developed on an open-source platform. The drawback of this approach is that the cost of assembling and calibrating the Sensorem hardware may disincentivize users, who would instead opt to rely on neighbors to make the capital investment.

Alternatively, private contract could be issued. A foreseeable use case would be the distribution of the sensors to a pollutant-producing business, in order to verify that they are meeting pollutant emission standards. The business could order a contract that includes several sensors, which would be disseminated amongst field workers. The information generated could be owned by the company, having the application route the data to a separate database. The company could use this information to influence decisions regarding their adherence to the *Clean Air Act*. The company could also use the data jointly with the EPA, to corroborate their pollutant footprint.

Finally, the Sensorem system can be marketed toward government contracts. Institutions like the EPA, or its subsidiaries, could equip their employees with these pollutant monitors and generate government data related to AQI in their respective regions. A hypothetical use case in this domain would be distributing these sensors among park rangers in a national park in order to map the pollutant concentrations. Government-facing contracts may offer the most viability given the governments maintained interest in preserving the quality of the atmosphere.

10. WASTE GENERATION AND PUBLIC INVOLVEMENT

As a system that is powered by public involvement, Sensorem hopes to bring accountability to air quality maintenance. As any user can collect data about air quality in their region, the ability to identify trends related to pollutant densities will become apparent. This can help to both reinforce measurements taken by the OAQPS as well as assist in filling gaps in their air quality control network.

The only source of waste from this project are damaged lithium ion batteries that can no longer be charged. These batteries will need to be brought to landfills who have adequate receptacle for such waste.

11. CONCLUSION

The [REDACTED] Department of Electrical & Computer Engineering has created *Sensore*, an innovative method to seamlessly monitor air quality, filling gaps in the existing air quality detection network. Sensorem operates on crowd-sourced data point generation, utilizing a robust Cloud back-end to reliably store and visualize data. This approach can offer insights into air quality and pollutant exposure to both researchers and end users.

12. REFERENCES

1. SPEC Sensor Operation Overview, May 2016. from <http://www.spec-sensors.com/wp-content/uploads/2016/05/SPEC-Sensor-Operation-Overview.pdf>
2. AHA. (2016, October). Air Pollution and Heart Disease, Stroke. Retrieved March 04, 2018, from http://www.heart.org/HEARTORG/Conditions/More/MyHeartandStrokeNews/Air-Pollution-and-Heart-Disease-Stroke_UCM_442923_Article.jsp
3. TELAIRE, “SMART Dust Sensor” SM-PWM-01C datasheet, Oct. 2015
4. Royte, E. (2006, August). Corn Plastic to the Rescue. Smithsonian Magazine.
5. Amazon. (2018). AWS Pricing. Retrieved March 03, 2018, from <https://aws.amazon.com/mobile/pricing/>
6. Millipore Sigma. (2018). Retrieved March 6, 2018, from <https://www.sigmaaldrich.com/united-states.html>
7. Cavoukian, A., PhD. (2010). Redesigning IP geolocation: privacy by design and online targeted advertising (Canada, Information and Privacy Commission, Commissioner). Toronto, Ont.: Information and Privacy Commissioner.
8. Environmental Protection Agency. (2017, January 03). Clean Air Act Text. Retrieved March 06, 2018, from <https://www.epa.gov/clean-air-act-overview/clean-air-act-text>
9. Mintz, D. (may 2016). Technical assistance document for the reporting of daily air quality: the air quality index (AQI) (United State of America, U.S. Environmental Protection Agency, Research Triangle Park).

Audit of Health

For the scope of this safety audit, only concerns with lithium ion batteries (LIBs) will be discussed. The main components of a LIB include elemental lithium as the anode, graphite as the cathode, and electrolyte which is usually a lithium hexafluorophosphate solution.

To start, Lithium is considered a category 1 health hazard. Elemental lithium is a very reactive metal and readily oxidizes when exposed to air. Lithium reacts more seriously when exposed to moisture and water. The reaction emits hydrogen gas and from the spontaneity of the lithium/water reaction, a flash fire can be produced. Lithium, when in contact with the skin can be corrosive. It can cause severe skin burns and eye damage. All of this information is included in Sigma-Aldrich's safety data sheet.

As for the cathode, graphite, in comparison to the other chemicals it is considered nonhazardous.

Most of the issues that arise in LIBs are a result of the electrolyte. Lithium hexafluorophosphate (LiPF_6) solution is a category 3 flammable liquid, category 4 acute oral toxicity, and a category 2 skin and eye irritant. Repeated exposure via oral, the chemical targets the kidneys and repeated exposure via inhalation, the chemical targets the teeth and bones. LiPF_6 is dissolved in diethyl carbonate and ethylene carbonate, which is what causes the solution to be flammable and toxic respectively.

Problems with LIBs come from the short-circuiting of the battery. When this happens, it can cause the electrolyte to decompose into gases like CO_2 example. The production of this gas builds up pressure inside the cell and can cause it to break the seal and begin leaking electrolyte and cause a flash fire.

Internal failures of LIBs are just as bad as physical damage done to the battery itself. If the battery is punctured a flash fire can occur. If the puncture happens slowly, any pressure inside the battery releases slowly and can spray and volatilize the electrolyte causing it to ignite. If the puncture happens very quickly it will be less likely for a fire to happen, not to say that it isn't possible.

When incorporating LIBs into wearable devices, placement of the battery on the product is an important consideration to limit any physical damage the battery. Also, it would be good to avoid contact with the skin during battery operation. The solution to this problem was mentioned in the original proposal.

Overall, the use of a LIB in a wearable device is a very safe idea and only in extreme and rare cases are they hazardous and dangerous.

Names Deleted

Dr. *XXX* research lab

¹Department of Chemistry

²Institute of Material Science

Audit of Economics

Audit of Legal Issues

An audit for economics and for legal issues were not completed as this scope task did not require the need for one. Anything stated within the report's sections under their respective subjects gave sufficient information. This was deemed to be an acceptable response by the Engineering New Mexico Resource Network via a phone call.